

# CopitValves

Technology de México S.A. de C.V.

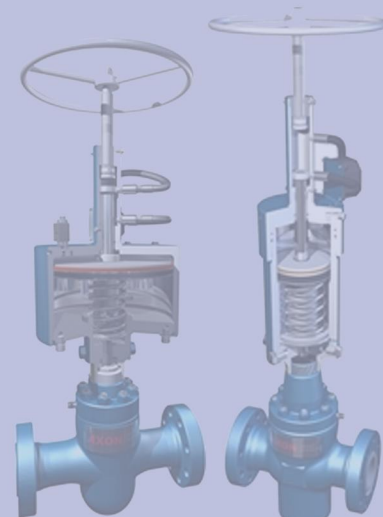

## CATALOGO 2016

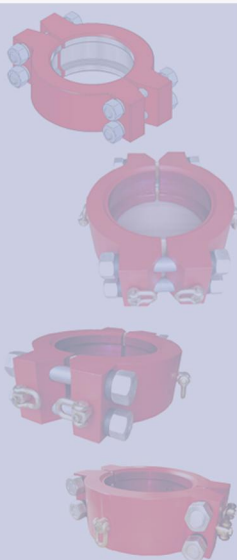



# CopitValves

Technology de México S.A. de C.V.

## Quienes Somos

Somos una empresa de distribución de equipos y accesorios, servicios de Mantenimiento reparación e instalación en el ámbito industrial.



**MISION**

Satisfacer las necesidades de nuestro clientes antes, durante y después del proyecto. Creando lazos de trabajo en equipo con nuestros proveedores y clientes



**VISION**

Ser Reconocidos y estar posicionados como una de las mejores empresas profesionales, seguras y responsables de México



**VALORES**

Calidad, Lealtad, Honestidad y Responsabilidad.

# CopitValves

Technology de México S.A. de C.V.

## VALVULAS DE SEGURIDAD

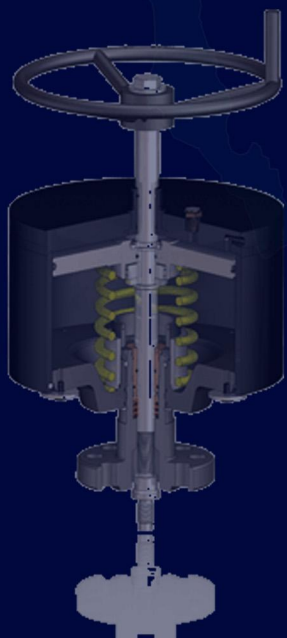

### ● VALVULAS DE SEGURIDAD NEUMATICA (A PISTON CON VOLANTE)

1 -13/16"10M, 1-13/16" 15M, 2-1/16" 5M,  
10M, 15M, 3-1/8" 5M

### ● VALVULAS DE SEGURIDAD NEUMATICA (A PISTON SIN VOLANTE)

1 -13/16"10M, 1-13/16" 15M, 2-1/16" 5M,  
10M, 15M, 2-9/16" 5M, 10M 15M, 3-1/8" 5M, 10M, 15M  
4-1/16" 5M, 10M, 5-1/8" 5M, 7-1/16" 5M

### ● VALVULAS DE SEGURIDAD CON ACTUADOR HIDRAULICO

1-13/16"10M,1-13/16"15M,2-1/16"5M,  
10M,15M,2-9/16"5M,10M15M, 3-1/8"5M,10M,15M4-1/16"5M,  
10M,15M,5-1/8"5M,10M,15M,7-1/16"5M,10M,15M

### ● INDICADOR DE POSICION ESTANDAR

### ● OVERRIDE ESTANDAR

ESTANDARES ESTABLECIDOS POR API CON ESPECIFICACION 6 A ULTIMA EDICION

# CopitValves

Technology de México S.A. de C.V.

## VALVULAS

### ● VALVULAS DE COMPUERTA

VALVULAS DE COMPUERTA DE ACERO AL CARBON (150 A 1500 LB / 2" -36")  
VALVULA DE COMPUERTA OPERADA POR ENGRANE (150 A 2500 LB / 2" -60")  
VALVULA DE COMPUERTA CON OPERACIÓN ELECTRICA (150 A 2500 LB / 2" -60")  
VALVULA DE COMPUERTA DE CUCHILLA ( CLASE 150-CLASE 300 / PN10-PN50 / 2" -32")  
VALVULA DE COMPUERTA DE ACERO FORJADO (150 A 1500 LB / 1/2" -2")  
VALVULA DE COMPUERTA DE ACERO INOXIDABLE (150 A 2500 LB / 1/2" -60")  
VALVULA DE COMPUERTA DE BRONCE (125 A 600 LB / 1/2" -24")  
VALVULA DE COMPUERTA DE FUELLE (150 A 600 LB / 2" -36")  
VALVULA DE COMPUERTA CRIOGENICAS (150 A 600 LB / 2" -36")  
VALVULA DE COMPUERTA DIN  
VALVULA DE COMPUERTA PLANA

### ● VALVULAS DE BOLA

VALVULAS DE BOLA TIPO TRUNNION / MONTADA SOBRE MUÑON (ANSI CLASE 150  
CLASE 300 -CLASE 400 -CLASE 600 -CLASE 900 -CLASE 1500 / 1" -40" )  
VALVULA DE BOLA CON EXTREMOS SOLDABLES ( 150 A 1500 LB / NPS2" -28" )  
VALVULA DE BOLA DE ACERO FORJADO / MONTADA SOBRE MUÑON  
(CLASE 150 A 1500 LB 2" -20")  
VALVULA DE BOLA FLOTANTE (CLASE 150 A 300 LB / 2" -24")  
VALVULA DE BOLA DE 3 VIAS (CLASE 150 300 LB -PN16 A PN40 / 1/2" -2")  
VALVULA DE BOLA DE ACERO INOXIDABLE (CLASE 150 A 1500 LB)  
VALVULA DE BOLA TIPO ENTRADA SUPERIOR (CLASE 150 A 2500 LB / 2"-48")  
VALVULA DE BOLA ROSCADA (3/8" -4")  
VALVULA DE BOLA ALTA PRESION CON SELLO METAL METAL  
(CLASE 150 A 2500 LB / NPS1/2" - NPS10")

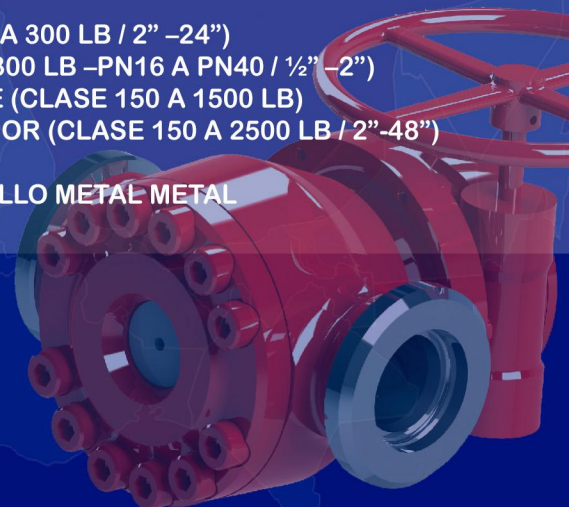

# CopitValves

Technology de México S.A. de C.V.

## VALVULAS



### ● VALVULAS DE RETENCION (CHECK VALVES)

VALVULA DE RETENCION TAPA ATORNILLADA, TIPO COLUMPIO, ROSCADA, EXTREMO SOLDABLES (CLASE 150 A 1500 LB / 2" -24")

VALVULA DE RETENCION CHECK TIPO MARIPOSA (CLASE 150 A 300 LB / 2" -36")

VALVULA DE RETENCION BRIDADA ( CLASE 150 A 600 LB / 1/2" -2")

VALVULA DE RETENCION TIPO PISTON ( CLASE 800 LB / 3/8" -2")

VALVULA DE RETENCION TIPO Y ( CLASE 800 LB / 3/8" -2")

### ● VALVULAS TIPO MACHO (PLUG VALVES)

VALVULA TIPO MACHO INVERTIDO LUBRICADO Y BALANCEO DINAMICO (CLASE 150 A 900 LB 1/2" -14")

### ● VALVULAS DE MARIPOSA

VALVULA DE MARIPOSA (CLASE 150 A 300 LB / 2"-36")

### ● VALVULAS DE GLOBO

VALVULA DE GLOBO DE ACERO FUNDIDO ( CLASE 150 A 1500 LB / NPS 2"-24")

### ● VALVULAS DE CONTROL

### ● ACTUADORES ELECTRICOS Y NEUMATICOS

DISEÑO Y FABRICACION API 608 API 6D, API 607, API 6FA, BS5351, ANSI B16.10, ANSI B16.5, API 598.



# CopitValves

Technology de México S.A. de C.V.

## CHOKES



- **CHOKE AJUSTABLE MANUAL DE JAULA**

1-13/16" A 7-1/16" DE 2000 A 15000 PSI

- **CHOKE POSITIVO**

1-13/16" A 7-1/16" DE 2000 A 15000 PSI

- **ACTUADOR NEUMATICO OPERADO**

1-13/16" A 7-1/16" DE 2000 A 15000 PSI

- **ACTUADOR ELECTRICO OPERADO**

1-13/16" A 7-1/16" DE 2000 A 15000 PSI



# CopitValves

Technology de México S.A. de C.V.

## CHOKES BEAN NIPLES DE ESTRANGULACION



### TAMAÑOS DISPONIBLES

4 / 64" A 128 / 64"

### H2 and H2 "Big John" Choke Seats



2" NOM x 1" MAX  
H-2  
1/2", 3/4", 1"  
Orifice  
2 1/4" Long  
1 11/16" Hex



2" NOM x 1" MAX  
H-2 "BIG JOHN"  
1/2", 3/4", 1"  
Orifice  
6" Long  
1 11/16" Hex



3" NOM x 2" MAX  
H-2  
2" Orifice  
3 3/16" Long  
2 3/4" Hex



3" NOM x 2" MAX  
H-2 "BIG JOHN"  
2" Orifice  
6" Long  
2 3/4" Hex



2" NOM x 1" MAX H-2br  
4/64 -64/64" Orifice  
2 1/4" Long 1 11/16" Hex



2" NOM x 1" MAX H-2  
"BIG JOHN"  
4/64 -64/64" Orifice  
6" Long 1 11/16" Hex



3" NOM x 2" MAX H-2  
"BIG JOHN"  
4/64 -128/64" Orifice  
6" Long 2 3/4" Hex



# CopitValves

Technology de México S.A. de C.V.

## BRIDAS Y CARRETES

### ● BRIDAS ADAPTADORAS

API 6A de 2000 a 15000 PSI

### ● CARRETES ESPACIADORES

API 6A de 2000 a 15000 PSI

### ● CARRETES ADAPTADORES

API 6A de 2000 a 15000 PSI

### ● CARRETES DE PERFORACION

API 6A de 2000 a 15000 PSI

API 6A Bridas  
API 16A Hubs & Clamps (N° 4,5,6 -20)  
Separador de Gas de Lodo, etc.

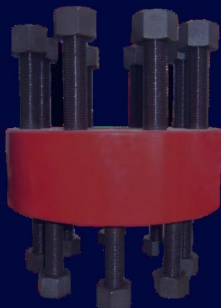
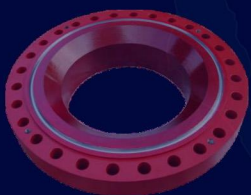
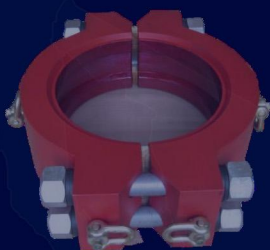
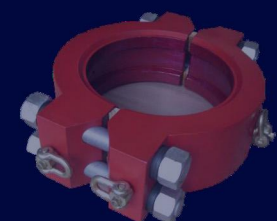

# CopitValves

Technology de México S.A. de C.V.

## BRIDAS Y ACCESORIOS



### BRIDAS

- LAP JOINT
  - ROSCADA
  - CIEGA
  - CONTRABRIDA
  - SOCKETWELD
  - WELDINGNECK
  - SLIPON
- TIPOS DE BRIDA: FF, RF, RTJ  
BRIDAS ESTANDAR: ANSI/ASME  
MATERIALES: ACERO AL CARBON

### ACCESORIOS PARA TUBERIA

- CODOS
- REDUCCION CONCENTRICA
- COPLES
- NIPOLETS
- TAPONCACHUCHA
- TUERCAS
- TEES RECTAS
- REDUCCION EXCENTRICA
- WELDOLETS
- THREADOLETS
- TAPONMACHO
- TEES REDUCIDAS
- SOCKOLETS
- FLANGEOLETS
- ESPARRAGOS

ESTANDAR: ANSI B16.9, ANSI B16.28, DIN 2605, DIN2615, DIN2616, JIS B2312, JIS B2313

MATERIAL: ACERO AL CARBON ASTM A105, A350 LF2, A694 F42, A694 F60, F694 F65  
ACERO INOXIDABLE ASTM A182-F304, F304L F316 F316L F321 ALEACION DE ACERO ASTM  
A182-F11, A182 F22

CEDULA: ACERO AL CARBON Y ALEACION DE ACERO STD, XS, XXS, SCH10-SCH160  
ACERO INOXIDABLE SCH5S, 10S, 40S, 80S



# CopitValves

Technology de México S.A. de C.V.

## ACCESORIOS

### ● RELE DETECTOR DE ARENA

RELE DETECTOR DE ARENA NM, HD, ALTA PRESION, ELECTICO Y ELECTRICO DE ALTA PRESION  
FABRICADO EN ACERO INOXIDABLE 3/16"  
NACE MR0175  
INCLUYE VALVULA DE 3 VIAS

### ● PROBETAS

TAMAÑOS: 2", 3" Y 4"  
CEDULAS: 40, 80, 160 Y XXH  
FABRICADAS EN ACERO AL CARBON Y ACERO INOXIDABLE 316

### ● FUSIBLES CONTRA FUEGO

FABRICADO EN ACERO INOXIDABLE 316  
NACE MR0175  
TAMAÑOS: 1/8", 1/4", 3/8", 1/2" NPT  
TEMPERATURAS: 158°F, 164°F, 183°F, 210°F, 255°F, 283°F, 361°F

### ● CONTROLADORES NEUMATICOS E HIDRAULICOS ENSAMBLADOS

ADITAMENTOS: PILOTOS DE CENSADO, MANIFOLD, VALVULA REGULADORA, RELAY INTERCONEXION DE TUBING DE ACERO INOXIDABLE DE 1/4".  
RANGOS DE PILOTOS: 10 A 10000 PSI

### ● JUEGOS DE PILOTOS

FABRICADO EN ACERO INOXIDABLE 316  
NACE MR0175  
RANGOS :10 A 10000 PSI



# CopitValves

Technology de México S.A. de C.V.

## CHOKE & KILL MANIFOLD

SEGUN ESPECIFICACION DEL CLIENTE

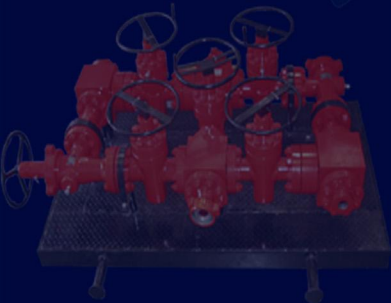
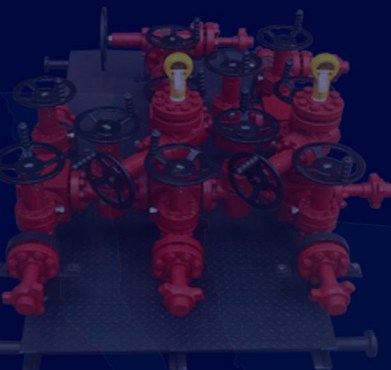

# CopitValves

Technology de México S.A. de C.V.

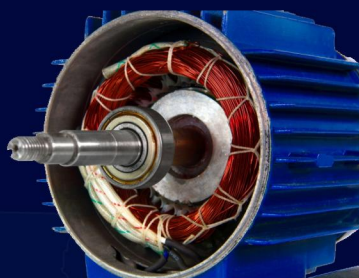

## MOTORES ELECTRICOS

MONOFASICOS Y TRIFASICOS PARA LA INDUSTRIA EN GENERAL

- PARA COMPRESORES DE AIRE
- PARA USOS GENERALES
- PARA USOS ESPECIALES
- PARA EFICIENCIA PREMIUM
- MOTO REDUCTORES
- A C / D C
- 115 VAC , 208 VAC, 230 VAC, 460 VAC, 796 VAC
- 825 RPM, 900 RPM, 1100 RPM, 1135 RPM, 1200 RPM, 1800 RPM, 3600 RPM
- 1 H.P/300 H.P
- NEMA 56 / 449 TS





# CopitValves

Technology de México S.A. de C.V.

Calle Rio amarillo centro No. 29 entre Rio ameca y Rio Magdalena  
Fraccionamiento Lomas de Rio Medio, Veracruz, Veracruz

Contacto: [arturo\\_copitvalves@yahoo.com](mailto:arturo_copitvalves@yahoo.com)

[rebeca.copitvalves@yahoo.com](mailto:rebeca.copitvalves@yahoo.com)

Tel: (229) 100-40-22

Cel.: (229) 257 45 87

REPRESENTANTE DE FABRICANTES  
DE USA, EUROPA Y ASIA



Distribuidor autorizado de JVS Flow Control  
4950, N. Sam Houston, Parkway East,  
Houston - Texas - 77032  
[www.jvsflowcontrol.com](http://www.jvsflowcontrol.com)